

## Cyclone type CS

Spiral cyclones type CS are used for air treatment plants in the wood and paper industries and for corn and feed to separate chaff and corn dust in exhaust air from drying and cleaning plants.

They are made of rolled and riveted hot-dip galvanised sheet metal, but can be supplied in welded 2 - 3 mm sheet.

Type CS-20 is painted in RAL 5010.

Cleaning door in cone is an optional extra.

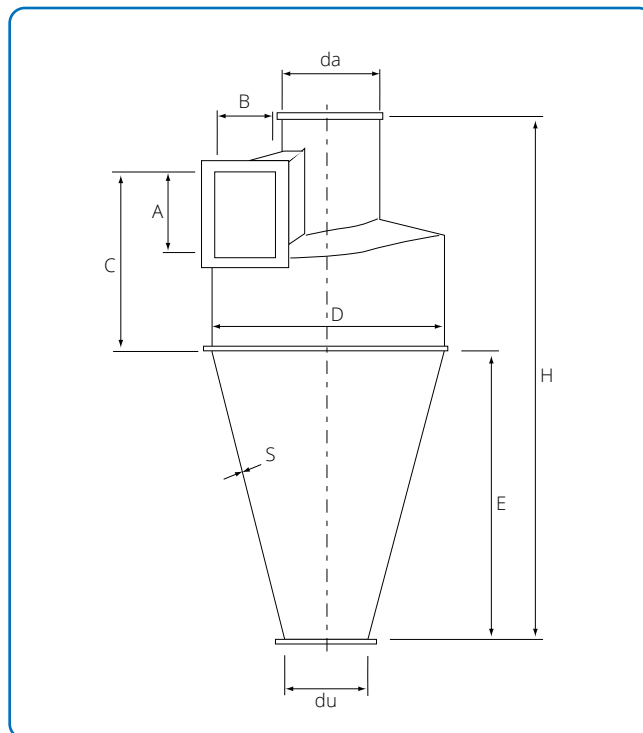
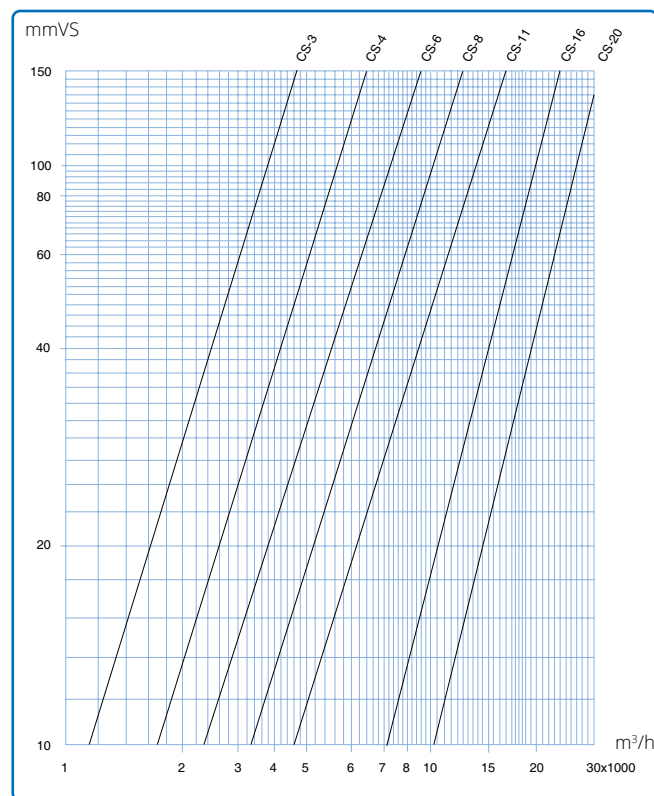

Dimensional specifications for lengths are given in the table below. Cleaning door is optional extra.

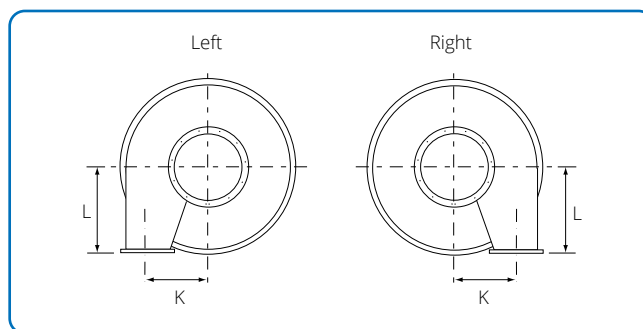

Dimensional specifications for lengths are given in the table below.

Type	Dimensions											Weight kg
	A mm	B mm	C mm	D mm	da mm	du mm	E mm	H mm	S mm	K mm	L mm	
CS-3	300	200	640	800	350	200	1150	1980	0.9	300	420	50
CS-4	350	250	740	950	400	200	1330	2280	0.9	350	500	65
CS-6	400	300	840	1100	450	250	1500	2580	0.9	400	580	80
CS-8	450	350	950	1300	500	250	1700	2930	0.9	475	675	120
CS-11	530	400	1130	1550	600	300	1900	3310	0.9	575	790	170
CS-16	640	480	1350	1850	750	300	1900	3600	0.9	685	970	210
CS-20	800	500	1410	2014	1000	400	1700	3450	2.00	757	980	360